

CVI329X3



| | |
|-----------------|----------------|
| Product Family | Wine Cooler |
| Installation | Built-in |
| Built-In Niche | 60 cm |
| Defrost | Automatic |
| Cooling type | Fan assisted |
| Hinge type | Variable hinge |
| Hinge position | Right |
| Reversible door | Yes |



Wine cellar compartment features



| | |
|---|---------------------------|
| Number of fixed shelves | 1 |
| Number of removable shelves | 2 |
| No. of lights | 2 |
| Shelves material | Wood |
| Removable shelves on telescopic guide rails | Yes |
| Type of internal light | LED |
| Air filter | Activated charcoal filter |

Programs / Functions



| | | | |
|-------------------|--------------------------------------|--------------------|---------------------|
| Control setting | Touch control | Control lock | Yes |
| Controls | Inner, in the cellar compartment | Lighting forced ON | In a maximum period |
| Display | LED | Fan forced ON | Yes |
| Functions display | Temperature alarm, Temperature value | Temperature Alarm | Yes |
| Power on lamp | Yes | Door open alarm | Yes |

Technical Features

| | | | |
|------------------------------|---|-----------------------|--------------------------|
| Adjustable temperature zones | 2 | Number of compressors | 1 |
| | | Compressor type | Low vibration compressor |
| | | Refrigerant gas type | R600a |

| | | | |
|------------------------------------|------------|--|-------|
| Independent cooling systems | 1 | Refrigerant Quantity (gr) | 20 g |
| Number of door glasses | 2 | Foam agent | HFO |
| Temperature range | 5-20 °C | Metal panel on the back of the fridge | Metal |
| Type of temperature control | Electronic | | |
| Anti-UV door glass | Yes | | |
| Integrated heating element | Yes | | |

Performance / Energy Label NEW





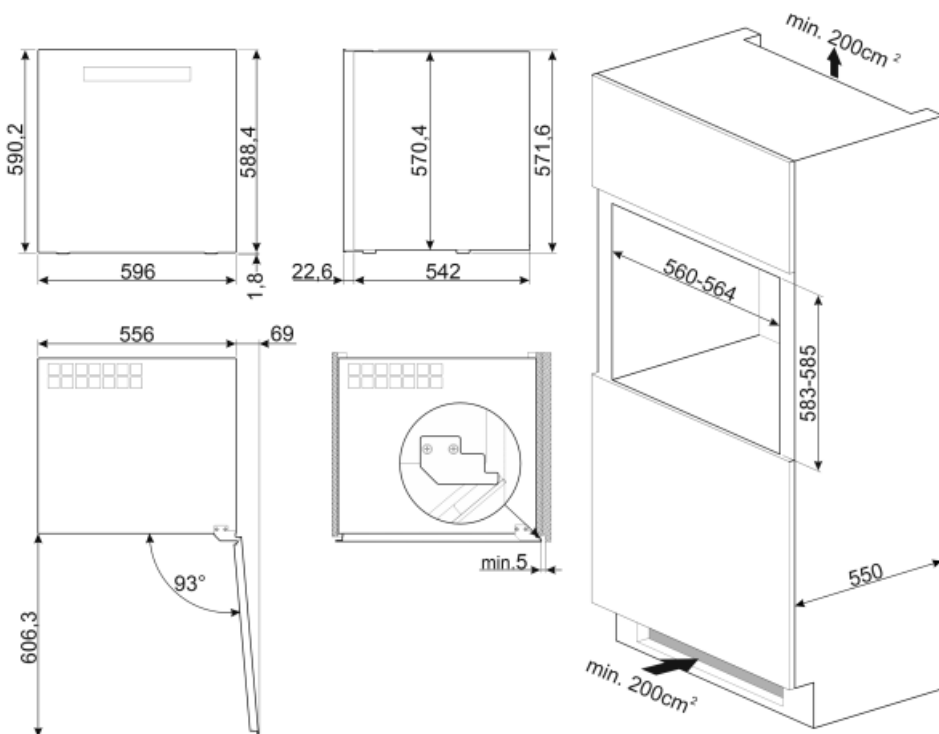

| | | | |
|--|--------------|---|-----------------|
|  | | | |
| Annual energy consumption | 140 KWh/year | Sum of the volumes of the chill compartment(s) and the unfrozen compartment(s) | 79 l |
| Energy efficiency class | G | Climatic class | SN, N, ST |
| Airborne acoustical noise emission class | C | EEI | 170 % |
| Total volume | 79 l | Noise level | 38 dB(A) re 1pW |

Electrical Connection

| | | | |
|----------------------|--------------|----------------------------------|-----------|
| Plug | (F;E) Schuko | Voltage (V) | 220-240 V |
| Nominal power | 40 W | Frequency (Hz) | 50 Hz |
| Current | 0.4 A | Power supply cable length | 150 cm |



Symbols glossary

- | | | | |
|--|--|---|---|
|  | The automatic defrost system works by automatically defrosting at regular intervals eliminating the need to defrost altogether. |  | LED display: to show programmes, functions and options selected and the time to the end of the cycle. |
|  | Energy efficiency class G |  | A: Product drying performance, measured from A+++ to D / G depending on the product family |
|  | Ventilated: Forced distribution of cold air in the refrigerator compartment, which allows even temperature distribution within the fridge. |  | LED interior lighting: is a more energy efficient and long lasting way of illuminating the interior of the appliance. |
|  | Touch controls: Easy to use touch controls allow the appliance to be programmed at the touch of a button. | | |