

# CVI629NR3

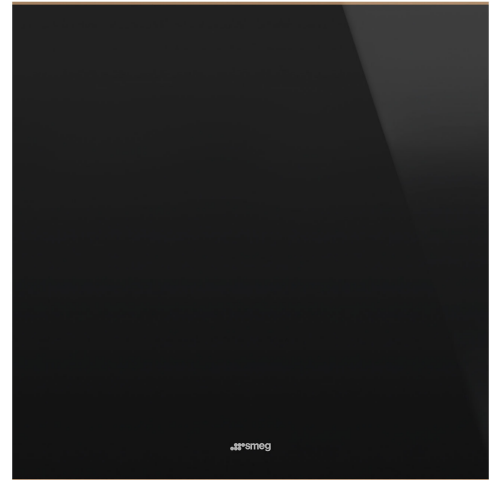

Product Family	Wine Cooler
Installation	Built-in
Built-In Niche	60 cm
Defrost	Automatic
Cooling type	Fan assisted
Hinge type	Variable hinge
Hinge position	Right
Reversible door	Yes



## Wine cellar compartment features



Number of fixed shelves	1
Number of removable shelves	2
No. of lights	2
Shelves material	Wood
Removable shelves on telescopic guide rails	Yes
Type of internal light	LED
Air filter	Activated charcoal filter

## Programs / Functions



Control setting	Touch control	Control lock	Yes
Controls	Inner, in the cellar compartment	Lighting forced ON	In a maximum period
Display	LED	Fan forced ON	Yes
Functions display	Temperature alarm, Temperature value	Temperature Alarm	Yes
Power on lamp	Yes	Door open alarm	Yes

## Technical Features

Adjustable temperature zones	2	Number of compressors	1
		Compressor type	Low vibration compressor
		Refrigerant gas type	R600a

<b>Independent cooling systems</b>	1	<b>Refrigerant Quantity (gr)</b>	20 g
<b>Number of door glasses</b>	2	<b>Foam agent</b>	HFO
<b>Temperature range</b>	5-20 °C	<b>Metal panel on the back of the fridge</b>	Metal
<b>Type of temperature control</b>	Electronic		
<b>Anti-UV door glass</b>	Yes		
<b>Integrated heating element</b>	Yes		

## Performance / Energy Label NEW

			
<b>Annual energy consumption</b>	140 KWh/year	<b>Sum of the volumes of the chill compartment(s) and the unfrozen compartment(s)</b>	79 l
<b>Energy efficiency class</b>	G	<b>Climatic class</b>	SN, N, ST
<b>Airborne acoustical noise emission class</b>	C	<b>EEI</b>	170 %
<b>Total volume</b>	79 l	<b>Noise level</b>	38 dB(A) re 1pW

## Electrical Connection



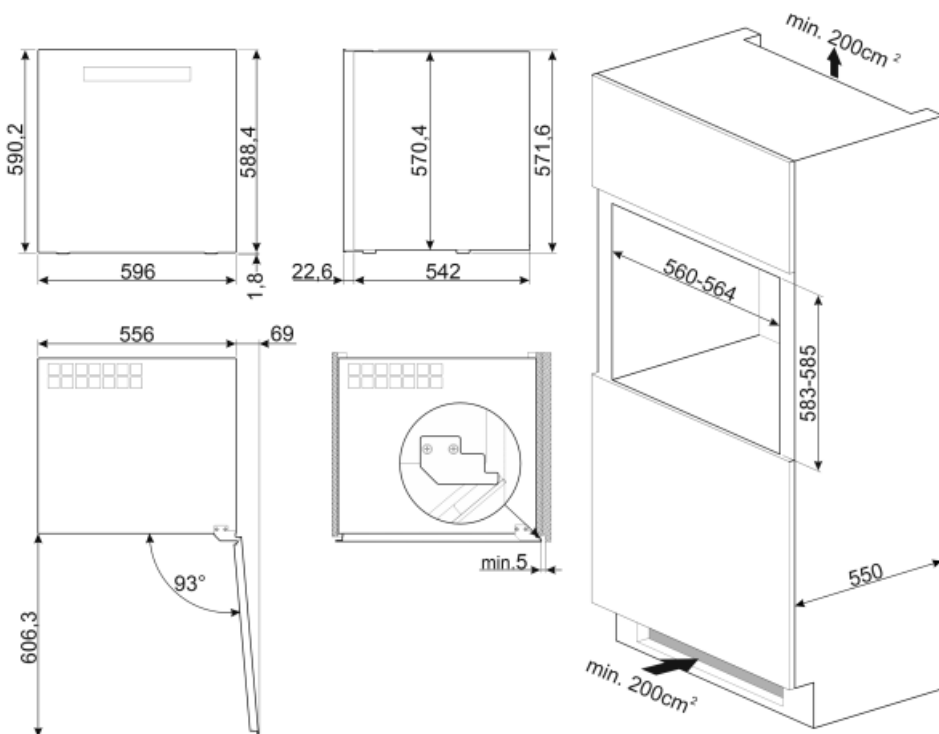



<b>Plug</b>	(F;E) Schuko	<b>Voltage (V)</b>	220-240 V
<b>Nominal power</b>	40 W	<b>Frequency (Hz)</b>	50 Hz
<b>Current</b>	0.4 A	<b>Power supply cable length</b>	150 cm



---

## Symbols glossary

---

- |                                                                                  |                                                                                                                                 |                                                                                   |                                                                                                                                            |
|----------------------------------------------------------------------------------|---------------------------------------------------------------------------------------------------------------------------------|-----------------------------------------------------------------------------------|--------------------------------------------------------------------------------------------------------------------------------------------|
|  | The automatic defrost system works by automatically defrosting at regular intervals eliminating the need to defrost altogether. |  | LED display: to show programmes, functions and options selected and the time to the end of the cycle.                                      |
|  | Energy efficiency class G                                                                                                       |  | Ventilated: Forced distribution of cold air in the refrigerator compartment, which allows even temperature distribution within the fridge. |
|  | LED interior lighting: is a more energy efficient and long lasting way of illuminating the interior of the appliance.           |  | Touch controls: Easy to use touch controls allow the appliance to be programmed at the touch of a button.                                  |