

# SCV115AS



Product Family	Wine Cooler
Installation	Free standing
Defrost	Automatic
Cooling type	Fan assisted
Hinge type	Standard
Hinge position	Left



## Wine cellar compartment features



Number of fixed shelves	1
Number of removable shelves	5
Number of removable and folding shelves	1
Shelves material	Wood
Adjustable shelves	Yes
Type of internal light	LED
Air filter	Activated charcoal filter

## Programs / Functions



Control setting	Control buttons	Control lock	Yes
Controls	External, in the lower socket	Temperature Alarm	Yes
Display	7 digits LED	Door open alarm	Yes

## Technical Features

Adjustable temperature zones	2	Compressor type	Low vibration compressor
Temperature range	5-22 °C	Refrigerant gas type	R600a
Type of temperature control	Electronic	Refrigerant Quantity (gr)	80 g
Anti-UV door glass	Yes	Foam agent	Cyclopentane
		Metal panel on the back of the fridge	Metal

Integrated heating element Yes  
Number of compressors 1

Adjustable feet 2 Front

## Performance / Energy Label NEW

	Annual energy consumption	181 KWh/year	Sum of the volumes of the chill compartment(s) and the unfrozen compartment(s)	368 l
	Energy efficiency class	G	Climatic class	SN, N, ST
	Airborne acoustical noise emission class	D	EEl	179 %
	Total volume	368 l	Noise level	42 dB(A) re 1pW

## Electrical Connection

Plug (F;E) Schuko  
Nominal power 200 W  
Current 1 A



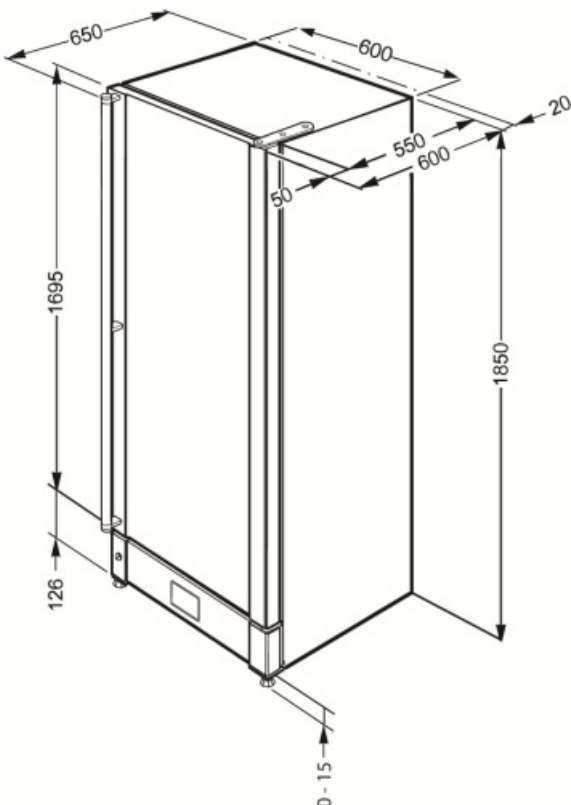



Voltage (V) 220-240 V  
Frequency (Hz) 50 Hz



---

## Symbols glossary

---

- |  |  |   |  |
|--|--|---|--|
|  | The automatic defrost system works by automatically defrosting at regular intervals eliminating the need to defrost altogether.            |  | LED display: to show programmes, functions and options selected and the time to the end of the cycle.              |
|  | Energy efficiency class G  |  | A: Product drying performance, measured from A+++ to D / G depending on the product family                         |
|  | Ventilated: Forced distribution of cold air in the refrigerator compartment, which allows even temperature distribution within the fridge. |  | Fingerprint proof stainless steel: Fingerprint proof stainless steel keeps stainless steel looking as good as new. |
|  | LED interior lighting: is a more energy efficient and long lasting way of illuminating the interior of the appliance.                      |   |  |