

SO4604M2PNR

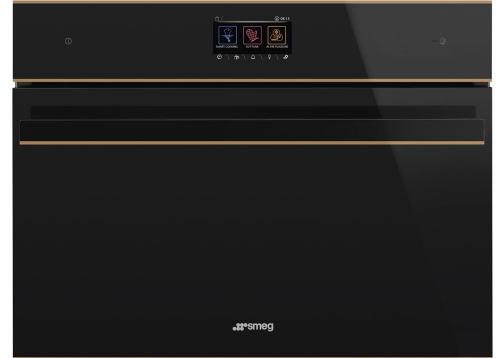

Category	45cm compact
Product Family	Oven
Power supply	Electric
Heat source	Electric
Cooking method	Combi Microwave
Galileo cavity	Speedwave
Cleaning system	Vapor Clean
EAN code	8017709325725



Aesthetics

Aesthetics	Dolce Stil Novo	Glass Type	Eclipse
Colour	Black	Door	Full glass
Finishing	Gloss	Handle	Dolce Stil Novo
Design	Flat	Handle Colour	Black
Component finish	Copper	Logo	Applied
Material	Glass		

Controls













Display name	VivoScreen	No. of display languages	20
Display technology	TFT	Display languages	Italiano, English (UK), Français (FR), Français (CA), Nederlands, Español (ES), Español (MX), Português (PT), Svenska, Русский, Deutsch (DE), Dansk, Norsk, Polski, English (AU), Suomi, Ukrainian, Kazakh, Afrikaans (ZA), Zulu (ZA)
Control setting	Touch control		







Programs / Functions

No. of cooking functions	15
Automatic programmes	150
Customisable recipes	10

Traditional cooking functions

 Static	 Fan assisted	 Circulaire
 Turbo (circulaire + bottom + upper + fan)	 ECO	 Large grill
 Fan grill (large)	 Base	 Circulaire + bottom
 Pizza		

Microwave functions

 Microwave	 Microwave + bottom + top + fan	 Microwave + circulaire + fan
 Microwave + grill	 Microwaves + Circulaire + bottom	 Warming and re-generation

Other functions

 Defrost by time	 Defrost by weight	 Proving
 Stone cooking	 BBQ	 Air-Fry
 Keep warm	 Plate rack/warmer	 Sabbath

Cleaning functions

 Vapor Clean
--

Options



Time-setting options	Delay start and automatic end cooking	SameTime	Yes
Minute minder	Yes	DeltaT cooking	Yes
Timer	3	Showroom demo option	Yes
Controls Lock / Child Safety	Yes	Demo-tutorial mode	Yes
Other options	Keep warm, Eco light, Language setting, Digital clock display, Brightness, Eco-logic, Tones, Tones volume	Touch guide	Yes
		History	Yes, the last 10 functions utilised
		Rapid pre-heating	Yes
		Instant GO	Yes
Cooking with probe thermometer	Yes		

Multi-step cooking	Yes, up to 2 steps
Smart cooking	Yes

Technical Features



Minimum Temperature	30 °C	Door	Temperate door
Maximum temperature	250 °C	Total no. of door glasses	4
Shelf positions	2	Microwave stops when door is opened	Yes
Shelves type	Metal racks	Soft Close hinges	Yes
Tilting grill	Yes	Soft Open	Yes
No. of lights	2	Inverter	Yes
Light type	LED	Stirrer	Yes
Light power	40 W	Safety Thermostat	Yes
Light when door is opened	Yes	Chimney	Double
Lower heating element power	1000 W	Cooling system	Tangential
Upper heating element - Power	1000 W	Cooling duct	Single
Grill element - power	1700 W	Usable cavity space dimensions (HxWxD)	214x462x397 mm
Large grill - Power	2700 W	Temperature control	Electronic
Circular heating element - Power	1400 W	Cavity material	Easy clean enamel
Heating suspended when door is opened	Yes	Microwave screen protection	Yes
Door opening type	Standard opening		

Performance / Energy Label



Net volume of the cavity	40 litres	Microwave effective power	900 W
Number of cavities	1		

Accessories Included



Chrome shelf	1	Telescopic Guide rails, total Extraction	1
Grill mesh	1	Temperature probe	Yes, multipoint
Glass tray	1		

Electrical Connection

Voltage	220-240 V	Frequency (Hz)	50/60 Hz
Current	13 A	Power supply cable length	150 cm
Nominal power (W)	3000 W		

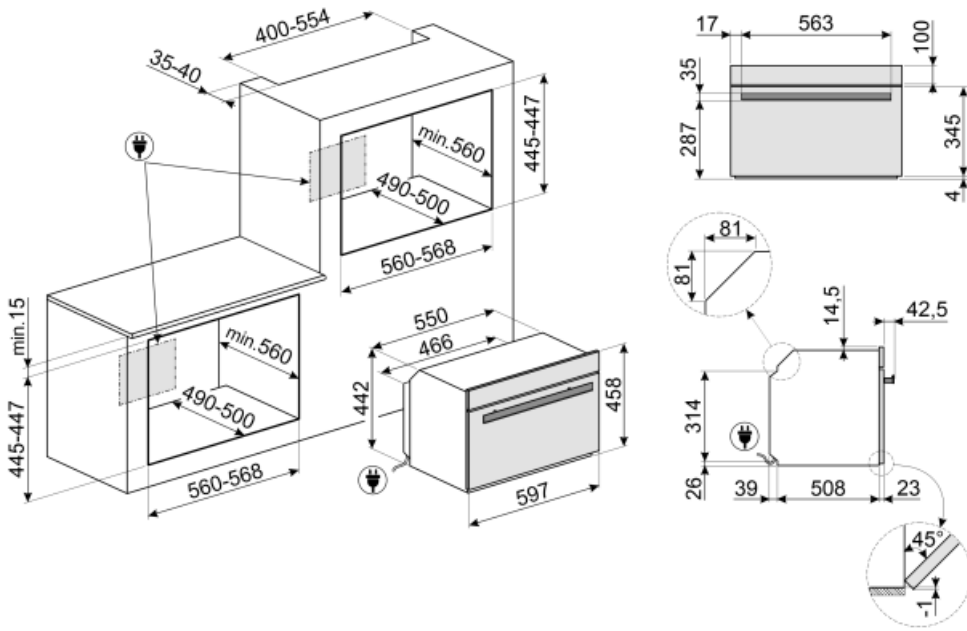



















Not included accessories





















AIRFRY

















Air fryer rack AIRFRY . Ideal for recreating traditional frying in the oven, but with fewer calories and less fat. It allows you to cook quickly and simply dishes such as French fries, fried vegetables and fish, ensuring perfect browning and crispiness.



Symbols glossary

 <p>Dedicated cooking function for the double sided plate BBQ. Suitable for recreating succulent and crispy dishes in the oven with the typical taste of g</p>	 <p>Child lock: some models are fitted with a device to lock the programme/cycle so it cannot be accidentally changed.</p>
 <p>Combination microwave: This oven allows to combine two different ways of cooking (Traditional with microwaves). Combined ovens increase cooking opportunities, while providing maximum flexibility of household appliances.</p>	 <p>Air cooling system: to ensure a safe surface temperatures.</p>
 <p>Defrost by time: with this function the time of thawing of foods are determined automatically.</p>	 <p>Defrost by weight: With this function the defrosting time is determined</p>
 <p>Quadruple glazed: Number of glazed doors.</p>	 <p>Automatic lighting switches off: for greater energy savings, the lighting switches off automatically after one minute from the start of cooking.</p>
 <p>ECO-logic: option allows you to restrict the power limit of the appliance real energy saving.</p>	 <p>Electric</p>
 <p>Enamel interior: The enamel interior of all Smeg ovens have a special antacid lining which helps keep the interior clean by reducing the amount of cooking grease adhering to it.</p>	 <p>Fan with upper and lower elements: The elements combined with the fan aim to provide more uniform heat, a similar method to conventional cooking, so pre-heat is required. Most suitable for items requiring slow cooking methods.</p>
 <p>Upper and lower element only: a traditional cooking method best suited for single items located in the centre of the oven. the top pf the oven will always be hottest. Ideal for roast, fruit cakes, bread etc.</p>	 <p>Lower heating element only: This function is ideal for foods that require extra base temperature without browning, e.g. pastry dishes, pizza. Also suitable for slow cooking of stews and casseroles.</p>
 <p>Circulaire with lower element: The addition of the lower element adds extra heat at the base for food which requires extra cooking.</p>	 <p>Circulaire: The combination of the fan and circular element around it gives a hot air cooking method. This provides many benefits including no preheat if cook time is more than 20 minutes, no flavour transfer when cooking different foods at the same time, less energy, and shorter cook times. Good for all types of food.</p>
 <p>ECO: The combination of the grill, fan and lower element is particularly suitable for cooking small quantities of food.</p>	 <p>Grill element: Using of grill gives excellent results when cooking meat of medium and small portions, especially when combined with a rotisserie (where possible). Also ideal for cooking sausages and bacon.</p>

- | | |
|--|---|
|  <p>Fan with grill element: The fan reduces the fierce heat from the grill, providing an excellent method of grilling various foods, chops, steaks, sausages etc. giving even browning and heat distribution, without drying out the food. The top two levels recommended for use, and the lower part of the oven can be used to keep items warm at the same time, an excellent facility when cooking a grilled breakfast. Half grill (centre portion only) is ideal for small quantities of food.</p> |  <p>Microwave: Penetrating straight into the food, microwaves cook very quickly and with considerable energy savings. Suitable for cooking without fat, they are also able to thaw and heat food without altering its original appearance and aroma. The microwave function can also be combined with conventional functions with all the resulting advantages. Ideal for all types of food.</p> |
|  <p>Cooking with the simultaneous use of the heating element in combination with fan and microwave supply.</p> |  <p>Microwave + grill element: The use of the grill results in a perfect browning of the surface of the food. The action of microwaves allows instead of cooking in a short time the internal part of the food.</p> |
|  <p>Fan combined with traditional cooking, where heat is generated from above and below, provides uniform heat. Adding the microwave function allows the same cooking results in less time.</p> |  <p>This function can reheat precooked dishes, without becoming dry or hard.</p> |
|  <p>Pizza function: The simultaneous operation of three elements ensures an optimum cooking facility when used with the Smeg pizza stone.</p> |  <p>Circulaire with upper and lower elements: The use of the fan with both elements allows food to be cooked quickly and effectively, ideal for large joints that require thorough cooking. It offers a similar result to rotisserie, moving the heat around the food, instead of moving the food itself, enabling any size or shape to be cooked.</p> |
|  <p>Compact appliances with a height of 45 cm - perfect solution to meet the functional requirements of kitchen sets of small height. Available in several types and in different styles.</p> |  <p>Keep warm: This function allows you to keep precooked foods warm.</p> |
|  <p>Warming up: An option for dish warming and keeping the prepared meals hot.</p> |  <p>Cooking with temperature probe: It is possible to display the temperature detected by the probe and set a target temperature that the dish must reach. When the core of the dish reaches the desired temperature, cooking stops</p> |
|  <p>Air at 40°C provides the perfect environment for proving yeast type dough mixes. Simply select the function and place dough in the cavity for allotted</p> |  <p>The 4.3" VIVOscreen display offers an advanced colour touch interface, for automatic management of firing programmes such as Delta T, Multi-step and SameTime firing.</p> |
|  <p>Rapid preheat: The rapid preheat function can be used to reach the selected temperature in just a few minutes.</p> |  <p>Sabbath: This function allows you to cook food whilst respecting the provisions of the Jewish day of rest.</p> |
|  <p>Touch guide: By holding down any symbol for 3 seconds you can get information on its function</p> |  <p>The oven cavity has 2 different cooking levels.</p> |
|  <p>Smart Cooking System: for the perfect cooking it is simply necessary choosing the kind and the weight of food and the cooking temperature: any other setting will be established automatically.</p> |  <p>Soft close: all models are equipped with advanced function of smooth closing of the door, which allows the device to close smoothly and quietly.</p> |

- | | |
|---|--|
|  <p>Telescopic rails: allow you to pull out the dish and check it without having to remove it from the oven entirely.</p> |  <p>Electronic control: Allows you to maintain temperature inside the oven with the precision 2-3 ° C. This enables to cook meals that are very sensitive to temperature changes, such as cakes, souffles, puddings.</p> |
|  <p>Tilting grill: the tilting grill can be easily unhooked to move the heating element and clean the roof of the appliance in one simple step.</p> |  <p>Touch controls: Easy to use touch controls allow the appliance to be programmed at the touch of a button.</p> |
|  <p>Vapor Clean: a simple cleaning function using steam to loosen deposits in the oven cavity.</p> |  <p>The capacity indicates the amount of usable space in the oven cavity in litres.</p> |
|  <p>...</p> |  <p>Instant go: activating this option allows cooking to start immediately. Preheating is included in the cooking time and the oven will gradually reach the desired temperature. Particularly suitable for frozen foods.</p> |
|  <p>Stirrer Active and controlled microwave distribution. The Microwave Stirrer fan distributes the waves evenly within the oven, reducing the need for a turntable.</p> |  <p>...</p> |
|  <p>Sametime: The perfect way to have a complete menu in a few simple steps. The SameTime algorithm calculates the times, the cooking functions and all the parameters so that 3 foods can be ready at the same time.</p> |  <p>The inverter technology allows to generate microwaves continuously and at the desired power The constant flow, without on and off cycles, allows you to precisely control the temperature, reduce times, avoids wasting energy and allows you to obtain excellent cooking, defrosting and re-heating results, thanks to the smaller difference between core and surface temperature in food</p> |
|  <p>Dedicated cooking function for the Air fryer rack AIRFRY . Ideal for recreating traditional frying in the oven, but with fewer calories and less fat.</p> |  <p>Dedicated cooking function for the rectangular refractory stone PPR2 Dimensions Ideal for cooking pizzas with the same results as a typical wood-fire</p> |
|  <p>Chimney: The double chimney technology creates a special airflow inside the cavity that reduce the condensation inside the cavity during microwave cooking.</p> |  <p>DeltaT cooking: The oven automatically sets the cavity temperature to a predefined temperature (named deltaT) higher than the core temperature detected by the probe. When the probe detects an extra degree at the core, the oven automatically increases also its internal temperature by one degree.</p> |