

TR90P2

| | |
|----------------------------------|-------------------|
| Cooker size | 90x60 cm |
| N. of cavities with energy label | 1 |
| Cavity heat source | ELECTRICITY |
| Hob type | Gas |
| Type of main oven | Thermo-ventilated |
| Cleaning system main oven | Catalytic |
| EAN code | 8017709322137 |
| Energy efficiency class | A |











Aesthetics



| | | | |
|-----------------------------|----------------------|----------------------------|------------------------|
| Aesthetic | Victoria | Colour of buttons | Black |
| Colour | Cream | No. of controls | 8 |
| Finishing | Cream | Serigraphy colour | Black |
| Design | Victoria | Handle | Smeg Victoria |
| Door | With frame | Handle Colour | Polished chrome |
| Upstand | Yes | Glass type | Black |
| Type of pan stands | Cast Iron | Feet | none |
| Hob colour | Black enamel | Plinth | Anthracite |
| Command panel finish | Enamelled metal | Storage compartment | Drawer |
| Control knobs | Smeg Victoria | Sliding compartment | Yes |
| Controls colour | Stainless steel | Logo | assembled 50's |
| Display | electronic 5 buttons | Logo position | Upstand+ Command panel |

Programme / Functions

No. of cooking functions 9
Traditional cooking functions

| | | |
|--|--|---|
|  Static |  Fan assisted |  Circulaire |
|  Eco |  Small grill |  Large grill |
|  Fan grill (large) |  Base |  Fan assisted bottom |

Cleaning functions

Catalytic

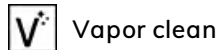

Other functions



Defrost by time

Hob technical features

UR

Total no. of cook zones 5

Front left - Gas - Rapid - 2.90 kW

Rear left - Gas - Semi Rapid - 1.80 kW

Central - Gas - 2UR (dual) - 5.00 kW

Rear right - Gas - Semi Rapid - 1.80 kW

Front right - Gas - AUX - 1.00 kW

Type of gas burners Standard

Gas safety valves Yes

Automatic electronic ignition Yes

Burner caps Matt black enamelled

Main Oven Technical Features



No. of lights 2

Fan number 2

Net volume of the cavity 115 l

Gross volume, 1st cavity 129 l

Cavity material Ever Clean enamel

No. of shelves 5

Type of shelves Metal racks

Light type Halogen

Light Power 40 W

Cooking time setting Start and Stop

Light when oven door is open Yes

Door opening Flap down

Removable door Yes

Full glass inner door Yes

Removable inner door Yes

Total no. of door glasses 3

No. of thermo-reflective door glasses 2

Safety Thermostat Yes

Cooling system Tangential

Usable cavity space dimensions (HxWxD) 371x724x418 mm

Temperature control Electro-mechanical

Lower heating element power 1700 W

Upper heating element - Power 1200 W

Grill element 1700 W

Large grill - Power 2900 W

Circular heating element - Power 2 x 1550 W

Grill type Electric

Soft Close system Yes

Options Main Oven

Timer Yes

Minimum Temperature 50 °C

Maximum temperature 260 °C

End of cooking acoustic alarm Yes

Accessories included for Main Oven & Hob

| | | | |
|------------------------------|---|------------------|---|
| Cast iron wok support | 1 | 40mm deep tray | 1 |
| Moka stand in cast iron | 1 | Grill mesh | 1 |
| Rack with back and side stop | 1 | Catalytic panels | 3 |
| 20mm deep tray | 1 | | |

Electrical Connection

| | | | |
|----------------------------------|-------------------|---------------------------|----------|
| Electrical connection rating | 3200 W | Power supply cable length | 120 cm |
| Current | 14 A | Frequency | 50/60 Hz |
| Voltage | 220-240 V | Terminal block | 3 poles |
| Type of electric cable installed | Yes, Single phase | | |

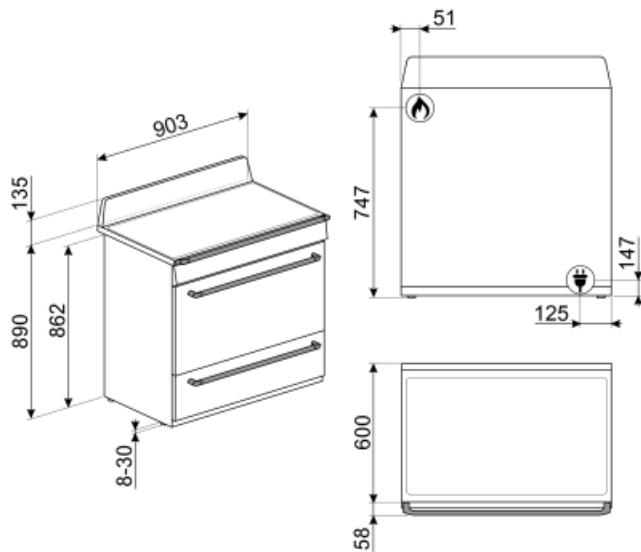

Not included accessories



TPKTR9

Stainless steel teppanyaki plate, suitable for Victoria TR9, Master and Sinfonia cookers



GTP

Partially extractable telescopic guides (1 level), suitable for traditional ovens. Made in stainless steel, they guarantee stability and facilitate the smooth extraction of the trays.



BGTR9

Cast iron grill plate suitable for 90 cm Victoria, 60 and 90 cm Master and Sinfonia cookers



KIT1TR9N

Splashback black, 90cm, suitable for TR90 and TR93 Victoria cookers



GT1P-2

Partially extractable telescopic guides (1 level) for ovens with metal frames. Length: 355.5 mm, extraction: 285 mm. Material: Stainless steel AISI 430 polished.



PALPZ

Pizza shovel with folding handle. Dimensions L31.5 x H32.5 cm. Easy and convenient to use and store. Perfect for serving pizza, bread and savory pastries in a safe and professional way.

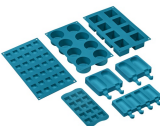

SMOLD

Set of 7 silicone moulds for ice creams, ice lollies, pralines, ice cubes or to portion food. Usable from -60°C to +230°C



AIRFRY9

Air fryer rack AIRFRY. Ideal for recreating traditional frying in the oven, but with fewer calories and less fat. It allows you to cook quickly and simply dishes such as French fries, fried vegetables and fish, ensuring perfect browning and crispiness.



PRTX

Refractory pizza stone with handles. D=35cm Not suitable for microwave ovens. Suitable for gas ovens, to be put on the griddle.



PPR9

Refractory pizza stone without handles. Squared shaped stone: L64xH2,3xP37,5 cm Suitable also for gas ovens, to be put on the griddle.



BBQ9



KITHTR90















Height extension kit (950mm), black, suitable for Victoria TR90 cookers (945-960mm)











GTT

Totally extractable telescopic guides (1 level), suitable for traditional ovens. Made in stainless steel, they guarantee stability and facilitate the smooth extraction of the trays.

Symbols glossary (TT)

| | |
|--|---|
|  <p>A: Product drying performance, measured from A+++ to D / G depending on the product family</p> |  <p>Heavy duty cast iron pan stands: for maximum stability and strength.</p> |
|  <p>Air cooling system: to ensure a safe surface temperatures.</p> |  <p>Defrost by time: Manual defrost function. At the end of the set duration, the function stops.</p> |
|  <p>Triple glazed doors: Number of glazed doors.</p> |  <p>Ever Clean Enamel: Ever Clean enamel is applied electrostatically, corner to corner and edge to edge to prevent cracking or cracks over time. It is a particular pyrolytic enamel, resistant to acids which, in addition to being pleasantly bright, promotes greater cleaning of the oven walls, thanks to its lower porosity. It is baked at over 850 ° C and slowly polymerized at a scientifically determined rate to ensure uniform depth and strength Ever Clean enamel creates an impeccable finish both on the inside of the oven and on the trays, making the surfaces of the oven incredibly easy to maintain over time as it reduces the adhesion of fat during cooking</p> |
|  <p>Fan assisted base: the mix of fan and lower heating element alone allows to finish cooking foods already cooked on the surface but not internally more quickly. This system is recommended to finish cooking foods that are already well cooked on the surface, but not internally, which therefore require a moderate higher heat. Ideal for any type of food.</p> |  <p>Fan assisted: Intense and homogeneous traditional cooking, also suitable for complex recipes. The fan is active and the heat comes from below and from above at the same time. Ventilated cooking ensures a faster and more homogeneous result, leaving fragrant foods outside and moister inside. Ideal for baked pasta, biscuits, roasts and cobblers.</p> |
|  <p>Static: Traditional cooking suitable for the preparation of one dish at a time. The fan is not active and the heat comes from below and from above at the same time. Static cooking is slower and more delicate, ideal in order to get well cooked and dry dishes even inside. Ideal for cooking all types of roasts, fatty meats, bread, filled cakes.</p> |  <p>Base: the heat comes only from the bottom of the cavity. The fan is not active. Ideal for sweet and savory pies, cobblers and pizzas. Designed to complete cooking and make food more crunchy This symbol in gas ovens indicates the gas burner.</p> |
|  <p>Circulaire: it is the perfect function for cooking all types of dishes in a more delicate way. The heat comes from the back of the oven and is distributed quickly and evenly The fan is active. It is also ideal for cooking on multiple levels without mixing smells and flavors.</p> |  <p>ECO: low energy consumption cooking: this function is particularly suitable for cooking on a single shelf with low energy consumption. It is recommended for all types of food except those that can generate a lot of moisture (for example vegetables). To achieve maximum energy savings and reduce time, it is recommended to put the food in the oven without preheating the cooking compartment</p> |
|  <p>Grill: Very intense heat coming only from above from a double heating element. The fan is not active. Provides excellent grilling and gratinating results. Used at the end of cooking, it gives a uniform browning to dishes.</p> |  <p>Half grill: For rapid cooking and browning of foods. Best results can be obtained by using the top shelf for small items, the lower shelves for larger ones, such as chops or sausages. For half grill heat is generated only at the centre of the element, so is ideal for smaller quantities.</p> |

-
- | | |
|--|---|
|  <p>Fan grill: very intense heat coming only from above from a double heating element The fan is active. It allows the optimal grilling of thickest meats. Ideal for large cuts of meat.</p> |  <p>All glass inner door: All glass inner door, a single flat surface which is simple to keep clean.</p> |
|  <p>The inner door glass: can be removed with a few quick movements for cleaning.</p> |  <p>Side lights: Two opposing side lights increase visibility inside the oven.</p> |
|  <p>The oven cavity has 5 different cooking levels.</p> |  <p>Soft close: all models are equipped with advanced function of smooth closing of the door, which allows the device to close smoothly and quietly.</p> |
|  <p>Ultra rapid burners: Powerful ultra rapid burners offer up to 5kw of power.</p> |  <p>Vapor Clean: a simple cleaning function using steam to loosen deposits in the oven cavity.</p> |
|  <p>The capacity indicates the amount of usable space in the oven cavity in litres.</p> | |