

FMI125G

Usable volume

25 l



Product Family

Microwave

Category

Built-in

Installation

Fully Built-in

Power supply

Electric

Cooking Method

Microwave with grill

Control

Electronic



Programme / Functions

No. of functions

6

Full grill



Pizza



Defrost by time



Defrost by weight



Microwave



Microwave + grill



Automatic programmes

8

Controls



Display / Clock

1 a LED

Opening

Electrical button

Type of control setting

Touch control

Options



Timer

Electronic

End of cooking acoustic alarm

Yes

Time-setting options

End cooking

Controls Lock / Child Safety Yes

Technical Features

Cavity material	Stainless steel	Door opening	Side-opening
No. of lights	1	Total no. of door glasses	1
Light type	Incandescent	Safety Thermostat	Yes
Turntable	Yes	Cooling system	Tangential
Turntable dimensions	31.5 cm	Microwave stops when door is opened	Yes
Light when door is opened	Yes	Usable cavity space dimensions (HxWxD)	221x370x334 mm
Grill type	Quartz	Microwave effective power	900 W
Grill - power	1000 W		

Accessories Included







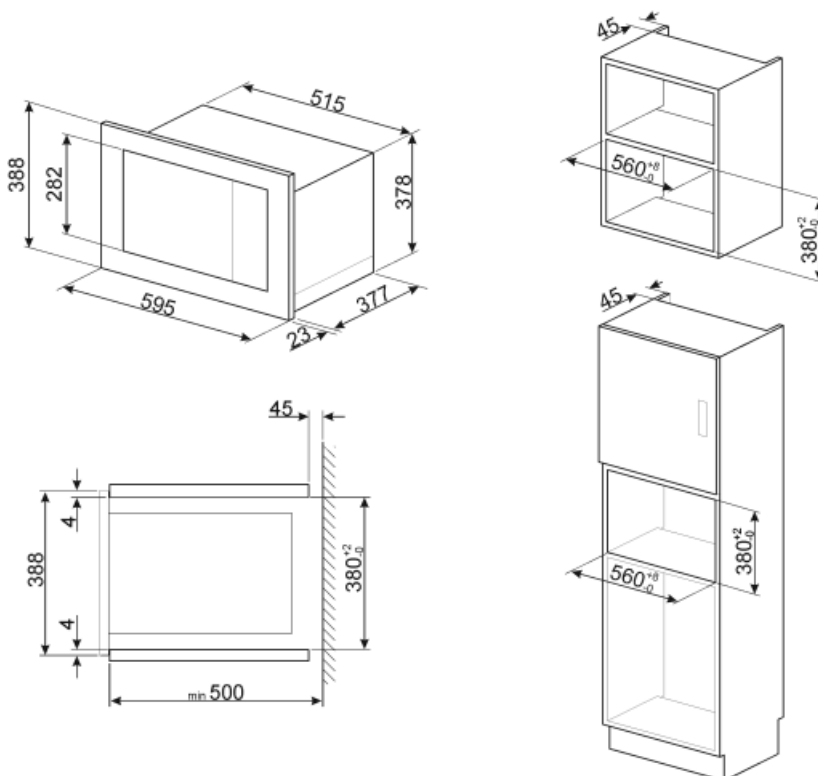



Grid	1	Other	Suction cup
-------------	---	--------------	-------------

Electrical Connection

Nominal power	1450 W	Frequency (Hz)	50 Hz
Current	6.3 A	Power supply cable length	130 cm
Voltage (V)	230 V		



Symbols glossary (TT)

- | | | | |
|--|---|---|--|
|  | Child lock: some models are fitted with a device to lock the programme/cycle so it cannot be accidentally changed. |  | Microwave energy shortens cooking times dramatically and produces energy savings. |
|  | Defrost by time: Manual defrost function. At the end of the set duration, the function stops. |  | Defrost by weight: Automatic defrost function. You choose the type of food to defrost from the available categories (MEAT - FISH - BREAD - DESSERTS) After entering the weight of the food, the oven automatically defines the time required for proper defrosting. |
|  | Grill: Very intense heat coming only from above from a double heating element. The fan is not active. Provides excellent grilling and gratinating results. Used at the end of cooking, it gives a uniform browning to dishes. |  | Microwave: Penetrating straight into the food, microwaves cook very quickly and with considerable energy savings. Suitable for cooking without fat, they are also able to thaw and heat food without altering its original appearance and aroma. The microwave function can also be combined with conventional functions with all the resulting advantages. Ideal for all types of food. |
|  | Microwave + grill element: The use of the grill results in a perfect browning of the surface of the food. The action of microwaves allows instead of cooking in a short time the internal part of the food. |  | Pizza microwave: This function cooks pizza quicker thanks to the microwaves. To optimize the final result, use the function combined with the Chef plate |
|  | Touch controls: Easy to use touch controls allow the appliance to be programmed at the touch of a button. |  | The capacity indicates the amount of usable space in the oven cavity in litres. |